

CellLog 8S

Cell Voltage Monitor&Logger



USER'S MANUAL

SHENZHEN JUNSI ELECTRONIC CO.,LTD



Thank you for purchasing the **CellLog 8S**. Please read the entire User's Manual completely and attentively as it contains a wide variety of specific programming and safety information.

Specifications

Lithium (LiPo/LiIo/LiFe) battery cell count:	2 – 8 series
Pack voltage range:	4.0 – 43.0VDC (USB can provide lower voltage 1.0V)
Alarm pack voltage range:	0.1 – 43.0VDC
Cell voltage range:	1.3 – 4.9VDC
Alarm cell voltage range:	1.3 – 4.9VDC
Voltage display resolution:	1mV
Current loading of test:	8mA
Maximum voltage for alarm port:	50VDC
Current drain for alarm port:	<500mA
Log Files storage:	16Mbit (36 hours@2 seconds logging interval)
Sample logging time interval:	0.5 – 60 seconds
PC Connect:	USB port
Weight:	18g
Dimensions (L X W X D):	62X39X12mm 2.44”X1.53”X0.47”

Special features





- Small size with multiple functions, backlight 128*64 lattices LCD and Buzzer Tone Reminder; the interface can be operated smoothly.
- **CellLog 8S** can not only measure 2-8S Li battery individual voltage, but also measure NiMH, NiCd, Pb battery pack voltage.
- It can be set Individual Voltage Alarm and Pack Voltage Alarm, Overvoltage Alarm, Low Voltage Alarm, Differential Voltage Alarm and Time Over Alarm. What's more, the extra alarm output can be linkage controlled by the users.
- It has 8 sets default monitor alarm settings, which can be selected for different battery packs.
- **CellLog 8S** has been 100% calibrated before it enters to the market, at the same time, it supports the calibration by users themselves.
- The logging interval can be set by users' different needs. **CellLog 8S** has a 16Mbit flash storage, which can log offline data in 36 hours @2 seconds logging interval.
- Support upgrading the hardware program by USB port. The **CellLog 8S** also supports the “logview” software and can display, plot and analyze the charge and discharge data by it. (See detail information about **logview** in the following website: <http://www.logview.info>)



Unpack inspection

The following items are included in the package. Contact your supplier if any items are missing.

Standard items:

<p>CDROM</p>  <p>85 X 85mm</p>	<p>CW-USB5</p>  <p>80mm</p>
<p>One copy of the User's manual on CDROM</p>	<p>One Mini-USB data line</p>
<p>CW-P220</p>  <p>20mm</p>	<p>CW-C220</p>  <p>20mm</p>
<p>One Alarm output line</p>	<p>One pack voltage measurements line with clips</p>

Optional items:

See details in "Optional parts" (P18)



External controls and connections



- 1. Input plug
- 2. LCD screen
- 3. Function button
- 4. USB port
- 5. Beep
- 6. Alarm port

CellLog 8S Connection Diagram

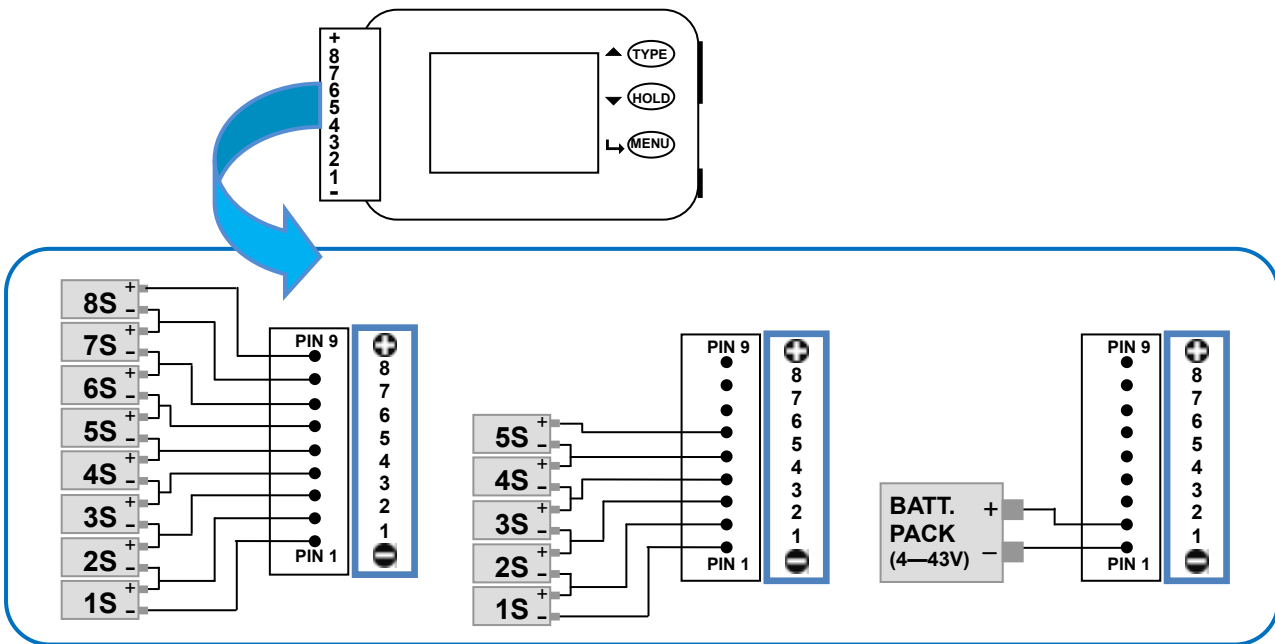



Program flow chart

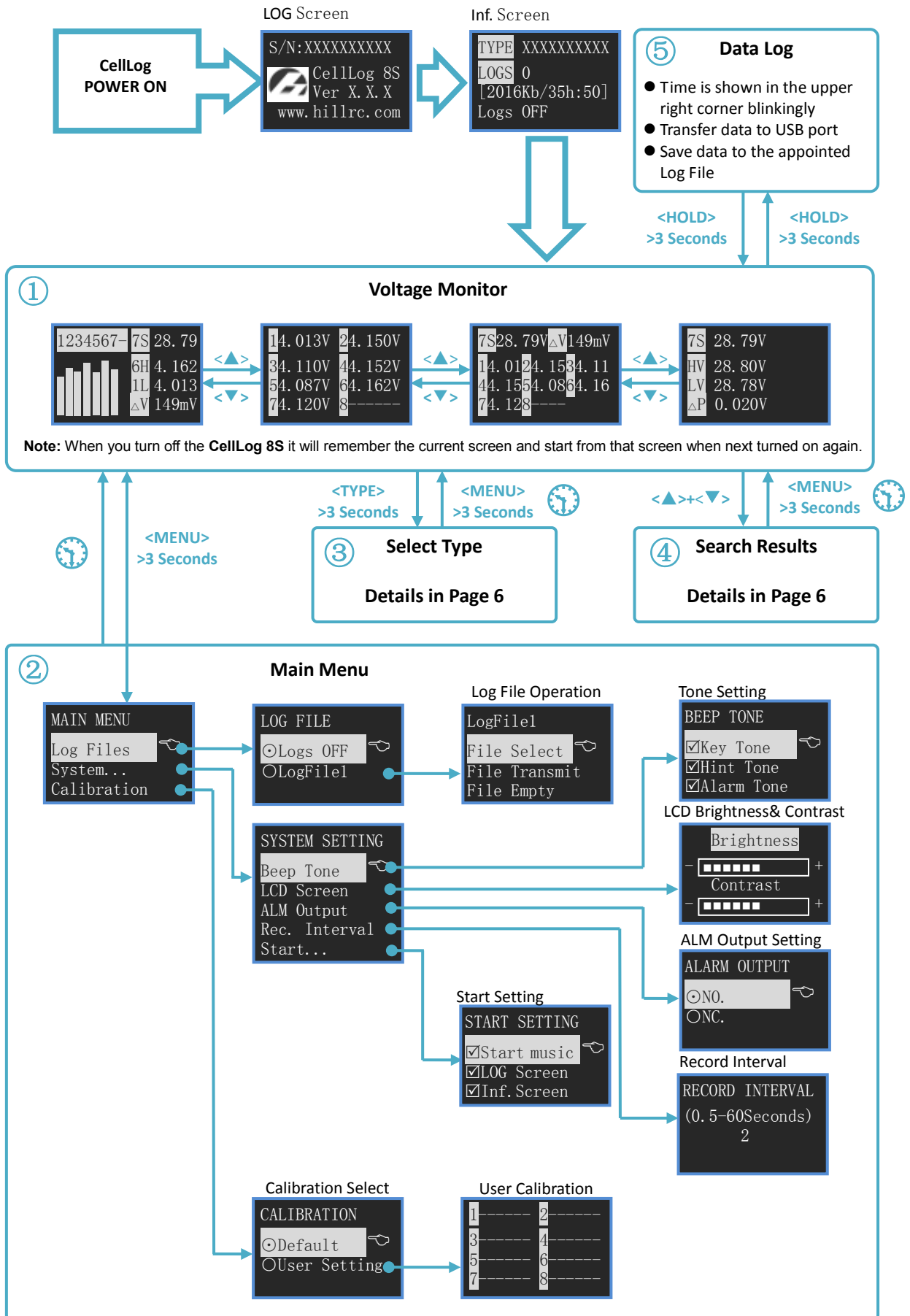

Note: 🕒 means if no operation on the button for 1 minutes, the system will return to monitor screen automatically.

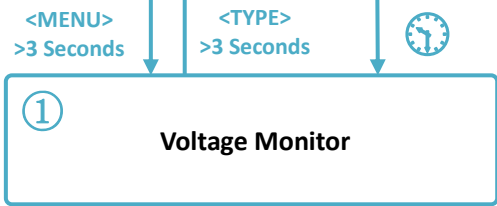
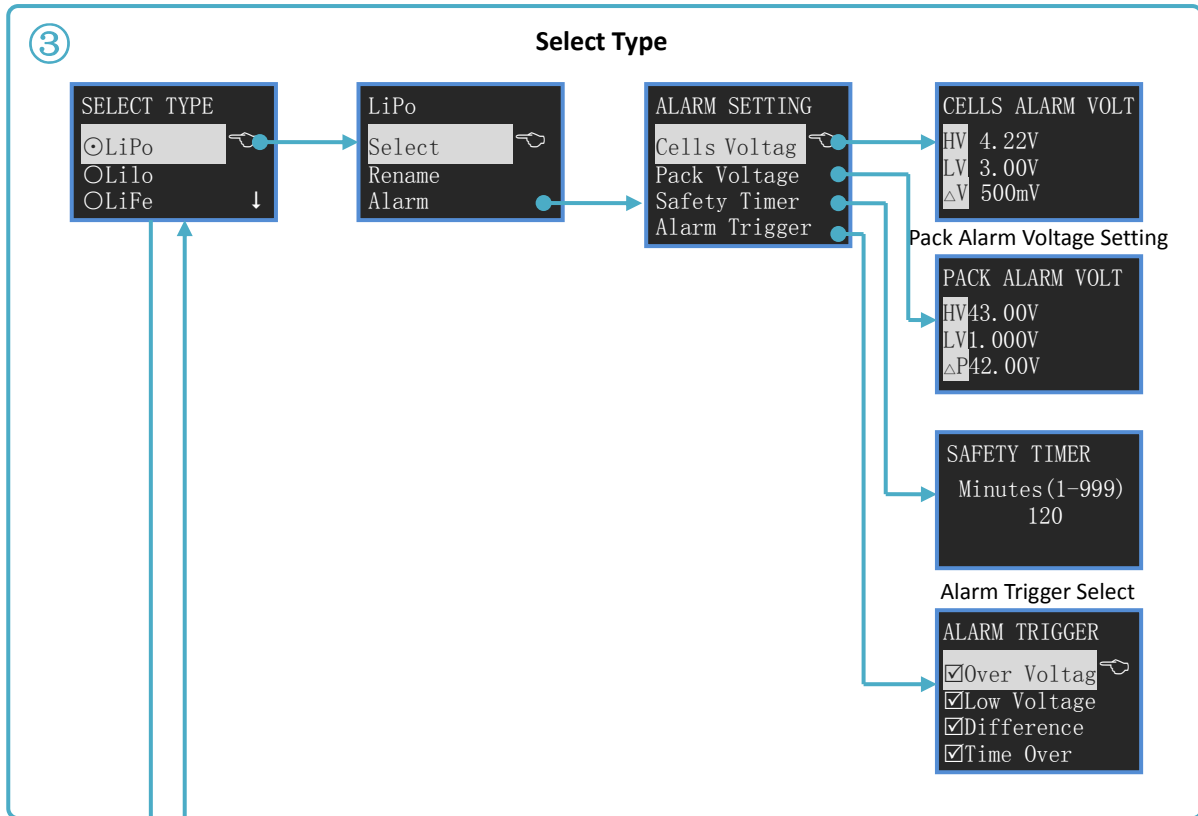

Note:
 means if no operation on the button for 1 minutes, the system will return to monitor screen automatically.

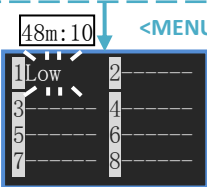
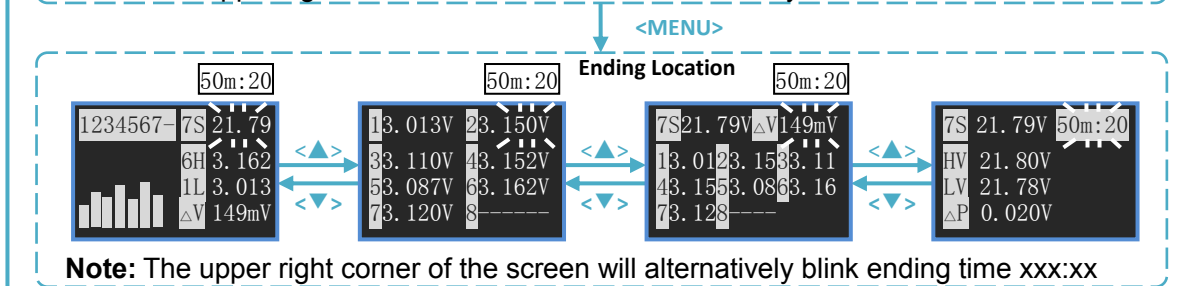
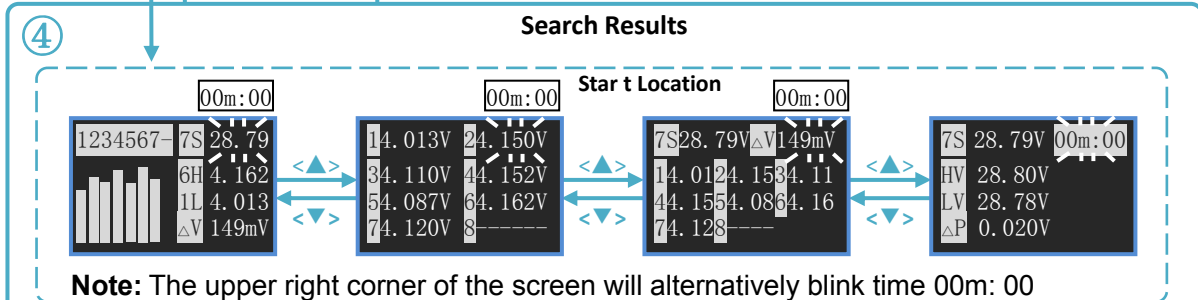

Alarm time points
 If there is alarm, the alarm events/alarm time will be shown alternatively at the corresponding battery number place.



Menu Operation:

1. Select the menu items by <▲> /<▼> buttons, the selected item will be shown in white.
2. Press <↔> to the following menu, and hold <↔> for more than 3 seconds, it will return to the upper menu.

Symbol Meanings:

Display Symbols	The meaning of the Symbols	Note
nS	total voltage of the pack	n:0-8, the cell count
nH	the highest individual cell voltage	n:0-8, the highest cell number
nL	the lowest individual cell voltage	n:0-8, the lowest cell number
ΔV	the maximum voltage difference between the cells	$\Delta V = nH - nL$
HV	The voltage maximum value	
LV	the voltage minimum value	
ΔP	the pack maximum voltage difference	$\Delta P = HV - LV$
$mmM:ss$ or $hhH:mm$	the time entering to logging	ss:second ,mm:minute , hh: hour
\odot/\circ	Single choice Do/Do not	
\checkmark/\square	Multiple choice Do/Do not	
T_OVER	Safety time alarm	
LOW	Low voltage alarm	
OVER	Over voltage alarm	
DIFF	Voltage difference alarm	

Button Function

CellLog has 3 buttons, which everyone owns the first and second functions. The first function is trigger after only one click; the second function is trigger after 3 seconds holding of the button.

Press button	Condition	Button Function Description
<▲>	Click	1. Turns up the menu 2. Increase the value 3. Select the character input
	Hold for 3 seconds	Enter to Alarm type select menu
<▼>	Click	1. Turns down the menu 2. Decrease the value 3. Delete the character
	Hold for 3 seconds	Trigger Open/Close Logging Function
<↔>	Click	Confirmation
	Hold for 3 seconds	Enter to System Setting Menu
<▲>+<▼>	Click	Check logging information
	Hold for 3 seconds	Save users voltage calibrated value

Note: <▲>+<▼> means pressing <▲> and <▼> at the same time.



QUICK START

● CellLog Power On

(2 ways: one is connecting the battery through the left 9 Pin socket, the other one is through the USB port), System self-check, and then shows the SN and version number, the display information are as below:

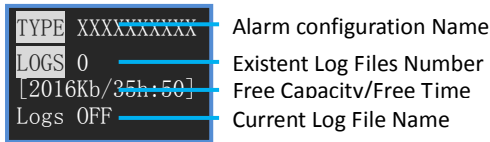

The first line is the current selected Setting Type (See detail in P10). The second line shows the log file number. And the third line is the available record of capacity and time. The last line shows the current log file name (if no files, it shows "Logs OFF"). 2 seconds later, the system enters to voltage monitor status.

● Voltage Monitor

There are 4 interface choices, which can be shifted by <▲> or <▼> buttons.

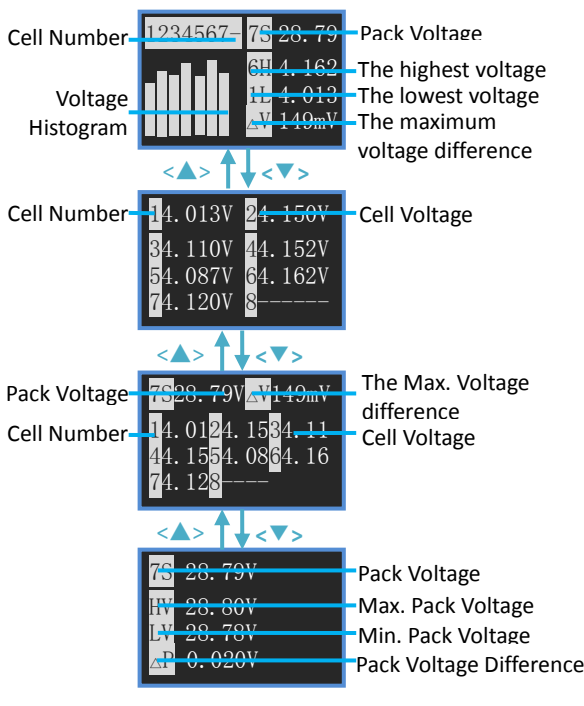

As the left pictures: the '7' in "7S" means cell counts; '6H' means the 6th cell voltage is the highest; '1L' means the 1st cell voltage is the lowest.

If the monitor voltage trigger alarm, the corresponding voltage and alarm display (LOW, OVER or DIFF) shows alternatively.

The cell number and (L, O, D) shows alternatively.

'LOW' or 'L' means: Low voltage alarm

'OVER' or 'O' means: Over voltage alarm

'DIFF' or 'D' means: Voltage difference alarm. They will be displayed at the same time at the highest and the lowest cell voltage interface.

Monitor the pack voltage

Display respectively: Current pack voltage, Max. Pack voltage, Min. Pack voltage, Pack voltage difference. (ΔP = HV-LV)

● Data Logging

When in Voltage Monitor status, press <▼> button for 3 seconds, after it shows "Start logging...", the calculagraph will be shown alternatively at the upper right corner of the LCD screen. In this status, the system will transmit the voltage data to USB port every X seconds(this interval time X can be set by user himself, details you can see Record Interl Time Setting in P13), and save these data to the current Log file (See Log File Management in P12. If 【Logs OFF】 , the system will not log file)

Press <▼> for 3 seconds again, the screen will show "Stop logging!" and then exit.

● View Logging Point

In the monitor status, press <▲> and <▼> at the same time to enter the view logging point status.

Three points voltage data can be searched:"Starting logging..."data, "Stop logging!" data, and the data of voltage alarm during this period , which can be shifted by <←> buttons. Press <←> for 3 seconds, it will return to the monitor status.

The saved data can be covered till next logging.

If the logging time is over the users setting safety time, (See Monitor Safety Time Setting in P11) , it will trigger Safety Time Alarm, and the screen shows "T_OVER" alternatively in the upper right corner.



● Alarm Remind

If CellLog detect the alarm events (See **Alarm Trigger Settings** in P11), it will remind as below:

1. The buzzer beeps every 4 seconds (【Alarm Tone】 is selected , See P13) .
2. The corresponding individual voltage and alarm remind show alternatively.
Alarm Remind Information: “LOW”, “OVER”, “DIFF”, “T_OVER”
3. ALM port will output the presetting signal.

ALM port signal information:

ALM output port signal is open collector signal, as showed below.

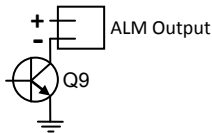

Please pay attention to the port voltage and current limit when you use (<50V,<500mA)

The following are ALM Output typical application.

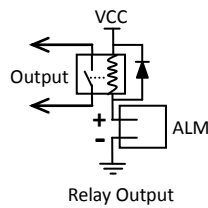
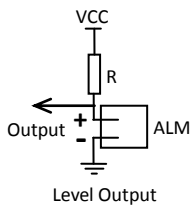



Monitor Alarm Settings

The system can have 8 sets alarm settings, press <▲> for 3 seconds to enter **SELECT TYPE** menu.

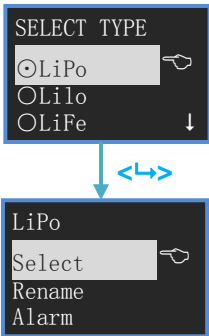

The item with ⊙ is the current setting.

<▲> or <▼> to select items and press <↔> button.

Defaulted TYPEs are: LiPo, Lilo, LiFe, User1--5

Operate the selected type settings

<▲> or <▼> to select the items, press <↔> to enter to the next step.

See details below.

- Note:** Press<▲> button to power on, it will shift to LiPo Type automatically.
- Press <▼> button to power on, it will shift to Lilo Type automatically.
- Press <↔> button to power on, it will shift to LiFe Type automatically.

- **Change Current Alarm Type:** Select **【Select】** , Press <↔> then the item will be with ⊙, and the settings come into effect.

- **Rename Alarm Type:** Select **【Rename】** , press <↔> and the screen shows:

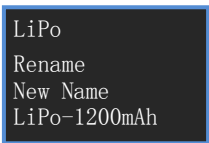

New Name Input Method: <▲> to select characters, hold it to trigger continuously; <▼> to delete the current character; <↔> to confirm the selected character; press <↔> for 2 times to confirm the amendment and return; press <↔> for 3 seconds to cancel and return.

- **Alarm Parameters Setting:** Select **【Alarm】** , press <↔> and the screen shows:

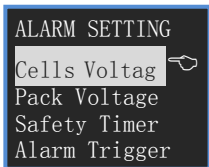

<▲> or <▼> to select items, press <↔> enter to the next step
See details below.

- 1) **Individual Cell Voltage Alarm Settings:** Select **【Cells Voltage】** , press <↔> and the screen shows:

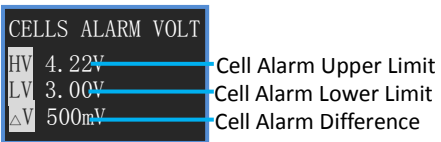

<▲> or <▼> to increase/decrease voltage value, press <↔> to shift setting items. Press <↔> for 3 seconds to confirm amendment and return.

[HV]: 1.31V—4.90V [LV]: 1.30V—4.89V [ΔV]: 0.01—3.60V

- 2) **Pack Alarm Voltage Setting:** Select **【Pack Voltage】** , press <↔> and the screen shows:

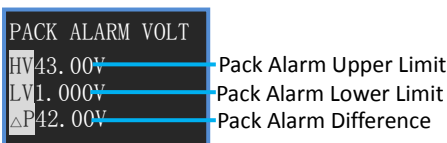

<▲> or <▼> to increase/decrease voltage value, press <↔> to shift setting items. Press <↔> for 3 seconds to confirm amendment and return.

[HV]: 1.05V—43.00V [LV]: 1.00V—42.95V [ΔP]: 0.05—42.00V



3) **Monitor Safety Time Setting:** Select **【Safety Timer】** , press **<↔>** and the screen shows:

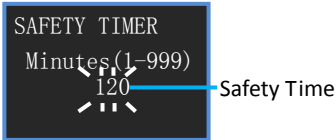

<▲> or <▼> to increase/decrease, press **<↔>** to confirm amendment and return. Press **<↔>** for 3 seconds to cancel amendment and return. Setting range: 1—999 minutes

4) **Alarm Trigger Settings:** Select **【Alarm Trigger】** , press **<↔>** and the screen shows:

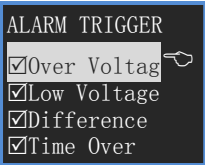

<▲> or <▼> to select items, press **<↔>** to shift select /, press **<↔>** for 3 seconds to confirm amendment and return.

Select **【Over Voltage】** Cell or pack voltage are over setting value, then it alarms.

Select **【Low Voltage】** Cell or pack voltage are lower setting value, then it alarms.

Select **【Difference】** Cell voltage is over or the pack voltage difference is over setting value, then it alarms.

Select **【Time Over】** entering HOLD status time is over setting safety time ,then it alarms.



Parameter Setup

Press <L> for 3 seconds, and enter to the **MAIN MENU**, Monitor status.

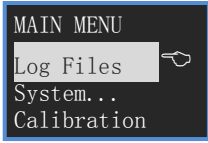

Log File Management: Select **Log Files** , press <L> and the screen shows:



The first item is **Logs OFF** ,if it is chosen, LOG function is close.

Press <▲> for 3 seconds to create new Log files.

Log file name input method:

<▲> to select characters, hold it to trigger continuously; <▼> to delete the current character; <L> to confirm the selected character; press <L> for 2 times to confirm the amendment and return; press<L> for 3 seconds to cancel and return.



The operation to the existing files:

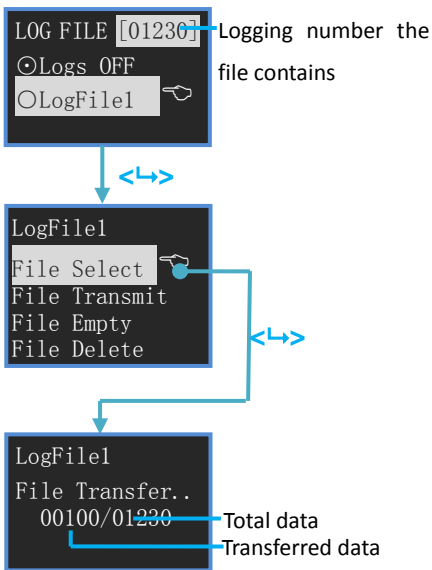

<▲> or <▼> to select items, press <L> to have a select order, press <L> for more than 3 seconds to return.

File Select The selected file is the current log file

File Transmit Transmit the selected log file to the USB port, it can be received by "LogView" (See details in P16)

File Empty Empty all selected log files. Press<L>, the screen shows "Are you sure you want to empty?", and press <L> to confirm, and any other press to cancel.

File Delete Delete the selected file. Press<L>, the screen shows "Are you sure you want to empty?", and press <L> to confirm, and any other press to cancel.



System Settings: Select **【System...】** , press **<↔>**, the screen shows:

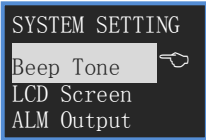

<▲> or <▼> to select items, press **<↔>** to have a select item, press **<↔>** for more than 3 seconds to return.
See details below.

1) **Beep Tone Settings:** Select **【Beep Tone】** , press **<↔>**, the screen shows:

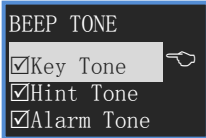

<▲> or <▼> to select the items, and press **<↔>** to shift select /, press **<↔>** for 3 seconds to confirm the amendment and then return.
Select **【Key Tone】** ,the buttons tone open.
Select **【Hint Tone】** ,the status tone open.
Select **【Alarm Tone】** ,the alarm tone open. (have a “Do” every 4 seconds)

2) **LCD Brightness & Contrast Setting :** Select **【LCD Screen】** , press **<↔>**, the screen shows:



<▲> increase, **<▼>** decrease, and press **<↔>** to shift Brightness/Contrast, press **<↔>** for 3 seconds to confirm the amendment and then return.

3) **Alarm Output Signal Type Setting: 【ALARM Output】**

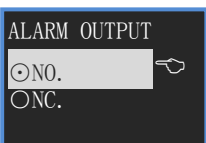

【NO.】 : Always On. Two output of ALM, it’s open when there is no alarm; It’s short circuit with alarm.
【NC.】: Always Close. Two output of ALM, it’s short circuit when there is no alarm; It’s open with alarm.

4) **Record Interval Time Setting: 【Rec. Interval】**

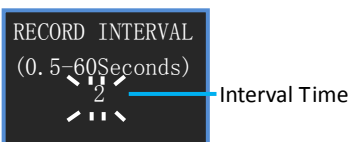

<▲> or <▼> to increase/decrease, press **<↔>** to confirm amendment and return. Press **<↔>** for 3 seconds to cancel amendment and return.
Setting range:0.5—60 Seconds

5) **Start-up Setting: 【Start...】**

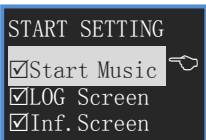

<▲> or <▼> to select the items, and press **<↔>** to shift select /, press **<↔>** for 3 seconds to confirm the amendment and then return.
Select **【Start Music】** , there will be a start music if you turn on
Select **【LOG Screen】** , it will display Log Screen if you turn on
Select **【Inf. Screen】** , it will display Information Screen if you turn on

Calibration Settings: Select **【Calibration】** , and press **<↔>**, the screen shows:

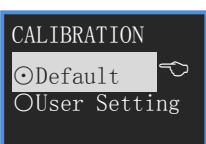

【Default】 : Calibration Default.
【User Setting】 : See details in P14



User Calibration

The CellLog 8S has been calibrated before entering to the markets, but if the users find that there is too much deviation, and then they can calibrate it as the following items:

Before calibration, you need prepare:

- 8s battery pack (the individual voltage ranges from 3.8-4.2V)
- 4½ Digital Multimeter

Calibrating steps:

1. Connect pack balance port to CellLog 8S to confirm there are 8 cell voltage display.
2. Press <MENU> for 3 seconds to enter Main Menu--【Calibration】-> CALIBRATION--【User Setting】, then it shows:

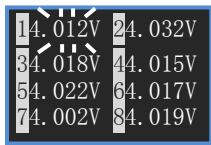

3. The current need-to-be calibrated voltage begins to blink (shows the voltage and calibrated value alternatively) , and use multimeter to measure the individual voltage corresponding to the blinking voltage. If the displayed value is more than the measured value, please press <▼> to decrease the displayed value to the measured value; vice versa, please press <▲> to increase the displayed value to the measured value. Press <↔> and shift to the next voltage calibration. In this way to get 8 sets voltage calibration.
4. Press <▲> and <▼> for 3 seconds to save the amendment and exit; Press <↔> for 3 seconds, it will cancel the amendment and exit.
5. The above is only for 8S individual cell measurement calibration, the methods are same for CellLog 8S measure port 1, 2 to measure pack voltage calibration. Connect 1, 2 to the battery pack's negative and positive pole respectively, then follow the Step 2, 3, 4.

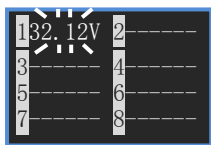

Note:

- If the user calibrates it in a wrong way, which damage the battery or cause other serious danger, our company will be of no responsibility.
- The users' calibrated value will not affect the calibrated before entering to the market. It can be selected by CALIBRATION--【User Setting】 or 【Default】 .



USB port installation

Install USB driver

This release of the USB driver is contained on the **CellLog 8S** software **CD-ROM**.

To install the USB driver, run the program **X:\USB driver\JunsiUSBInstaller.exe** (where **X** is the drive letter designator for your **CD-ROM** drive.)

Charger firmware upgrade steps

- Install the **CellLog 8S** USB driver
- Run the program **X:\Upgrader\Upgrader.exe** (you can download the **Upgrader.exe** software from the following website: <http://www.jun-si.com/UploadFiles/Upgrader.rar>).
- Connect the **CellLog 8S** to the PC using the supplied USB cable, choose “Device” in “Device List”, then select the upgrade file (you can download the latest file). The progress bar will appear after you click “Update...”

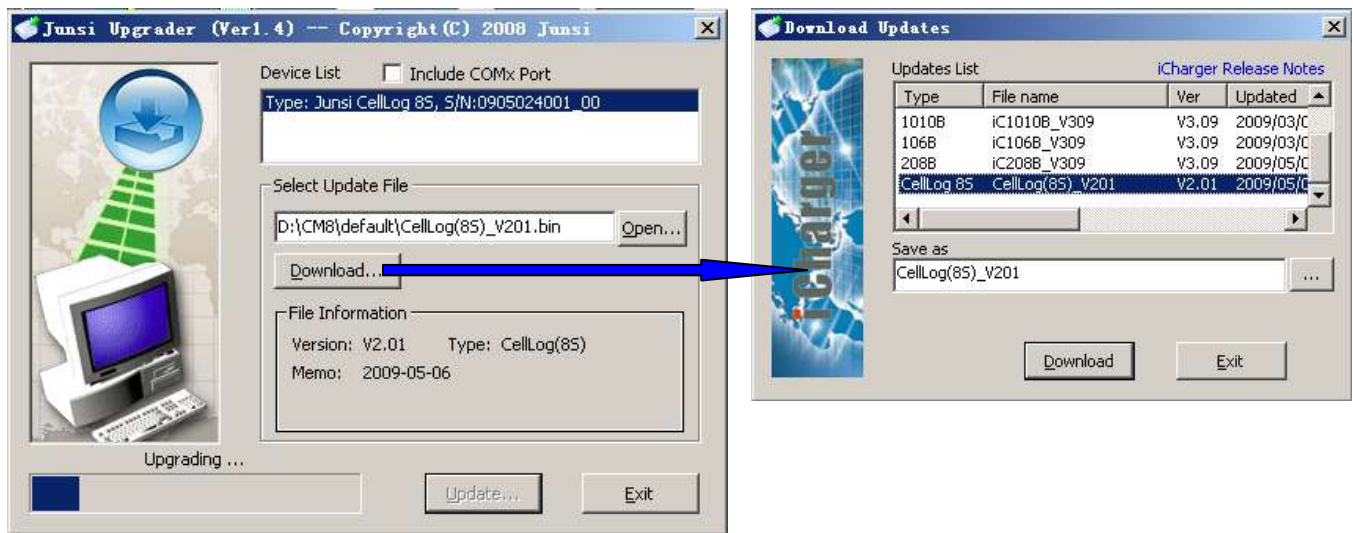



Using LogView for CellLog 8S

First, our sincere gratitude to the LogView development team: <http://www.logview.info>

Ensure you have installed the USB driver for the **CellLog 8S**.

Communication steps:

- To install **LogView**, run the program **X:\logview \ LogViewInstaller.exe** (where **X** is the drive letter designator for you **CD-ROM** drive.)
- Connect the **CellLog 8S** to the PC using the supplied USB cable
- Start **LogView** , then follow the illustrated instructions below:

1) Please choose language first, since the default language is German.

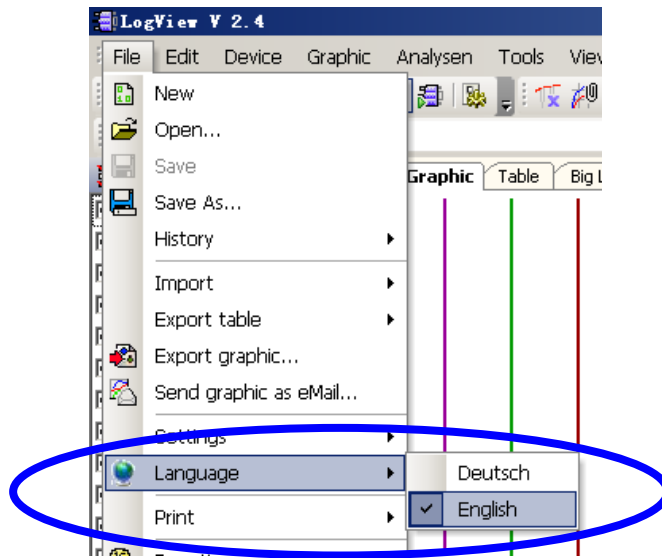

2) Click **Device**→**Choose device and port**.

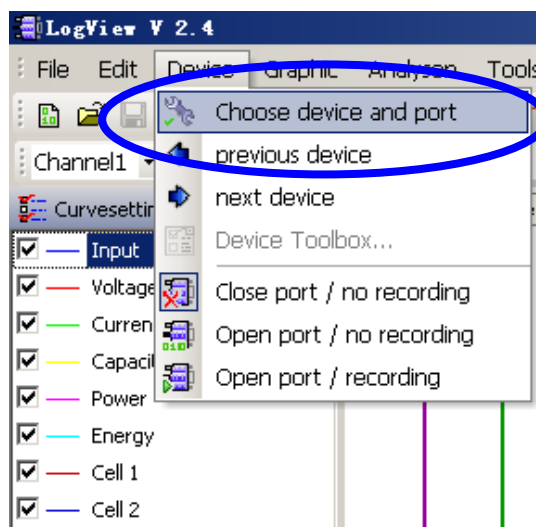



3) Choose **Junsi CellLog 8S** from the list and then choose the correct communication Port.

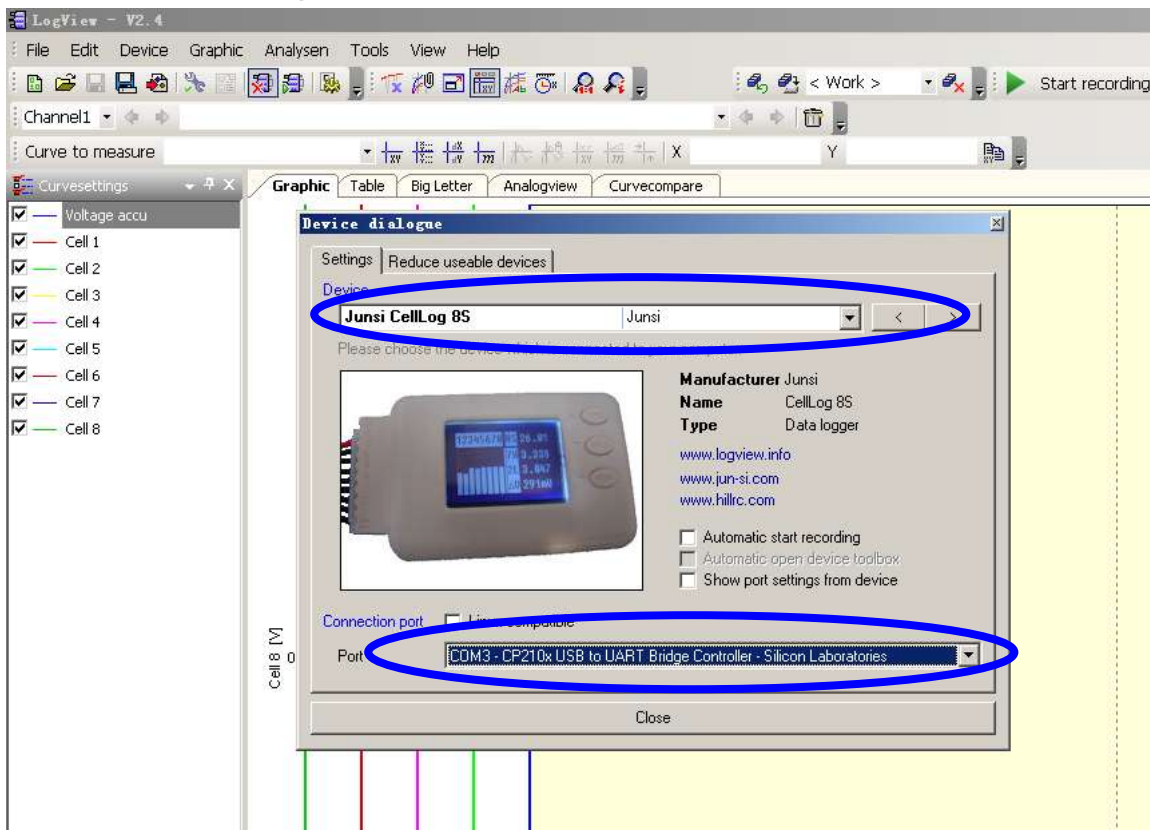

4) Click “Start recording” to record data.

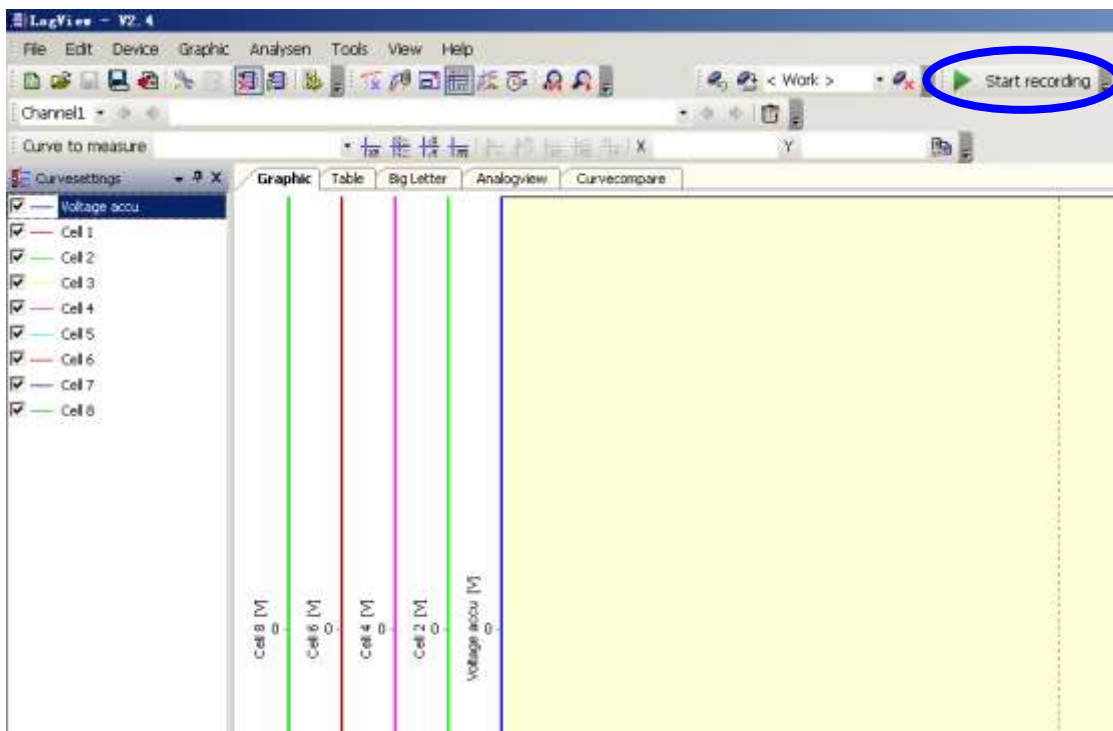

Refer to the **LogView** online help for more information about its features and operation.